

*BY APPROVING THIS DRAWING YOU ARE ENSURING THAT THESE DIMENSIONS HAVE BEEN FIELD VERIFIED.

APPROVED BY: _____ DATE: _____

REVISION REQUESTED

LIGHTED MIRROR SPECIFICATION REQUIREMENTS:
 UL 1598 approved including section 16.23 glass support test
 Finger print protection (edge frosted mirrors only)
 HardCoat - anti-corrosive backing
 Maintenance-free over 7 Years
 Safety Backed
 Made in America

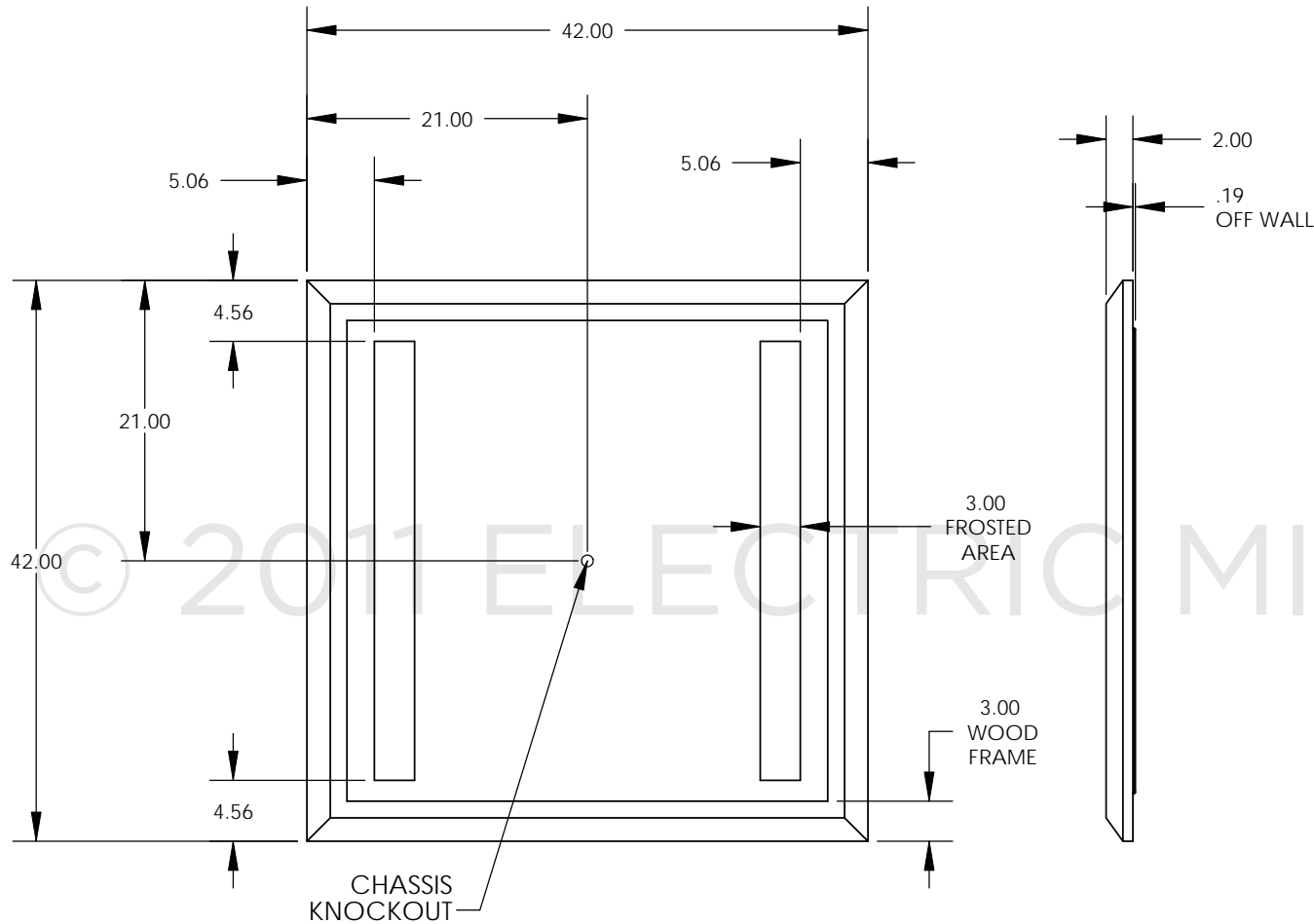

SPECIFICATION:

SPECIFY THE LIGHTING STATION ABOVE THE BATHROOM VANITY. THE TOP OF THE FIXTURE SHOULD BE A MINIMUM OF 6'6" OFF THE FINISHED FLOOR TO ACCOMMODATE THE HEIGHT OF A HOTEL GUEST.

THE MC CABLE IS BROUGHT IN THROUGH THE CHASSIS KNOCKOUT. INSERT GROUND WIRE IN GROUNDED CONNECTOR. INSERT HOT AND NEUTRAL WIRE INTO LUMINAIRE DISCONNECT. NO ELECTRICAL BOX REQUIRED. ELECTRICAL POWER SHOULD BE CONTROLLED BY A LIGHT SWITCH.

FIXTURE SHOULD BE MOUNTED TO A MECHANICALLY SOUND SURFACE SUCH AS WALL STUDS TO SUPPORT ITS WEIGHT. MOUNTING HOLES ARE PROVIDED IN THE CHASSIS.

POWER REQUIREMENTS:

120-277 VOLTS, .65 - .28 AMPS

LAMP SPECIFICATION:

NOMINAL LENGTH (in): 36
 NOMINAL WATTAGE: 39
 BULB: 2 X T5HO
 AVG RATED LIFE (hrs): 35,000
 CCT (K): 3000
 LUMENS: 3100
 CRI: 82

*PATENTED

ELECTRIC MIRROR [®] 2011 REF-42.00X42.00

SALES AID - 01-06-09

PROPRIETARY AND CONFIDENTIAL:

THE INFORMATION CONTAINED IN THIS DRAWING IS THE SOLE PROPERTY OF ELECTRIC MIRROR L.L.C. ANY REPRODUCTION IN PART OR AS A WHOLE WITHOUT THE WRITTEN PERMISSION OF ELECTRIC MIRROR L.L.C. IS PROHIBITED. © 2011 ELECTRIC MIRROR

DIMS IN INCHES	REV. A
SCALE: 1:14	PG.1 OF 2
CONTACT US: consultants@electricmirror.com T+1.425.776.4946	

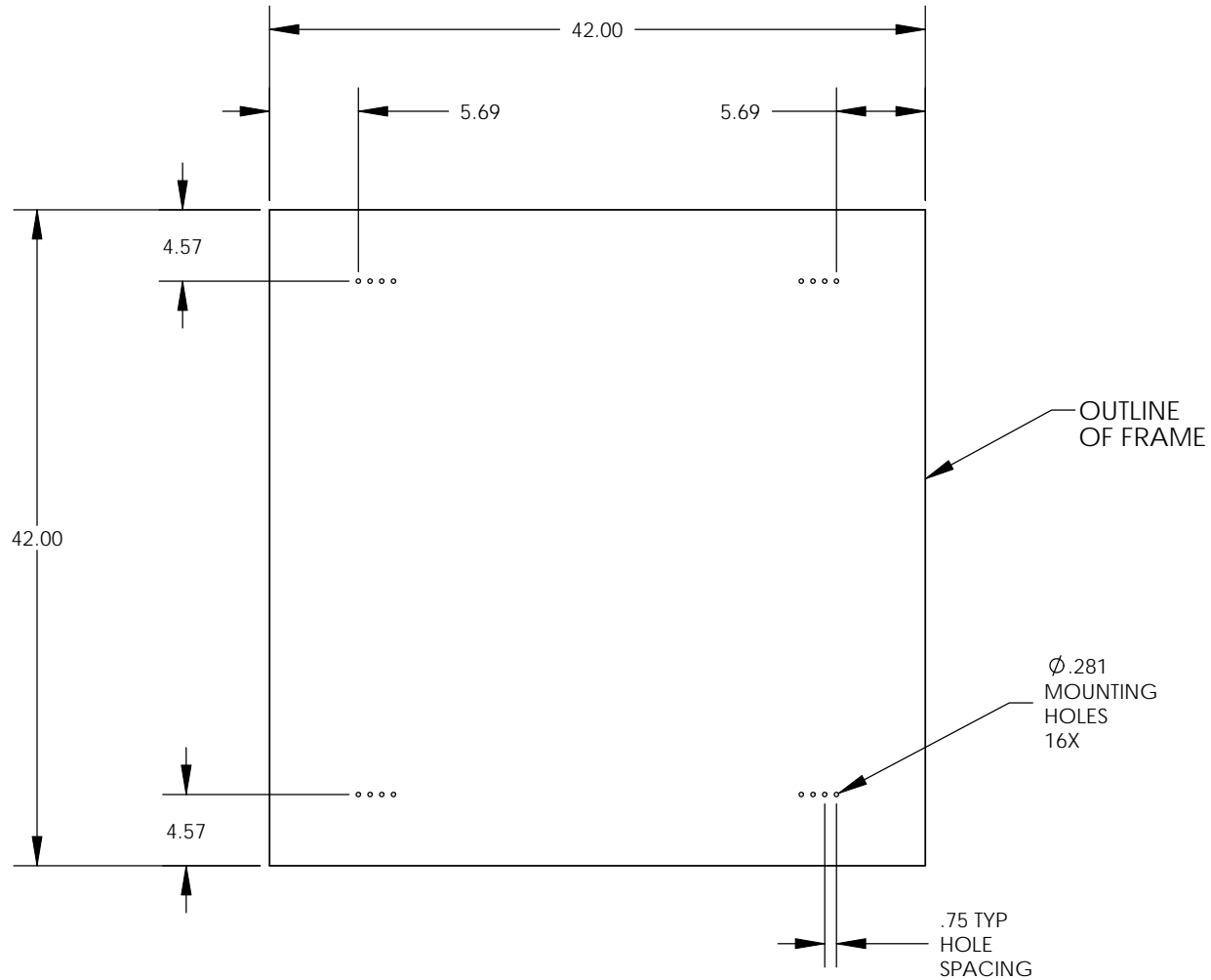

MOUNTING HOLE LOCATION

ELECTRIC MIRROR® 2011 REF-42.00X42.00

SALES AID - 01-06-09

PROPRIETARY AND CONFIDENTIAL:

THE INFORMATION CONTAINED IN THIS DRAWING IS THE SOLE PROPERTY OF ELECTRIC MIRROR L.L.C. ANY REPRODUCTION IN PART OR AS A WHOLE WITHOUT THE WRITTEN PERMISSION OF ELECTRIC MIRROR L.L.C. IS PROHIBITED. © 2011 ELECTRIC MIRROR

DIMS IN INCHES	REV. A
SCALE: 1:12	PG.2 OF 2
CONTACT US: consultants@electricmirror.com T+1.425.776.4946	